

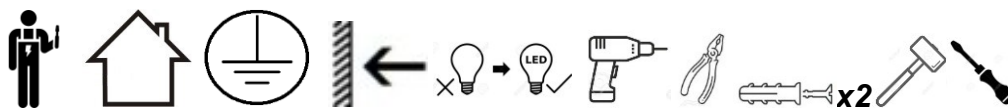

argon® LAMPY

LORD 8882

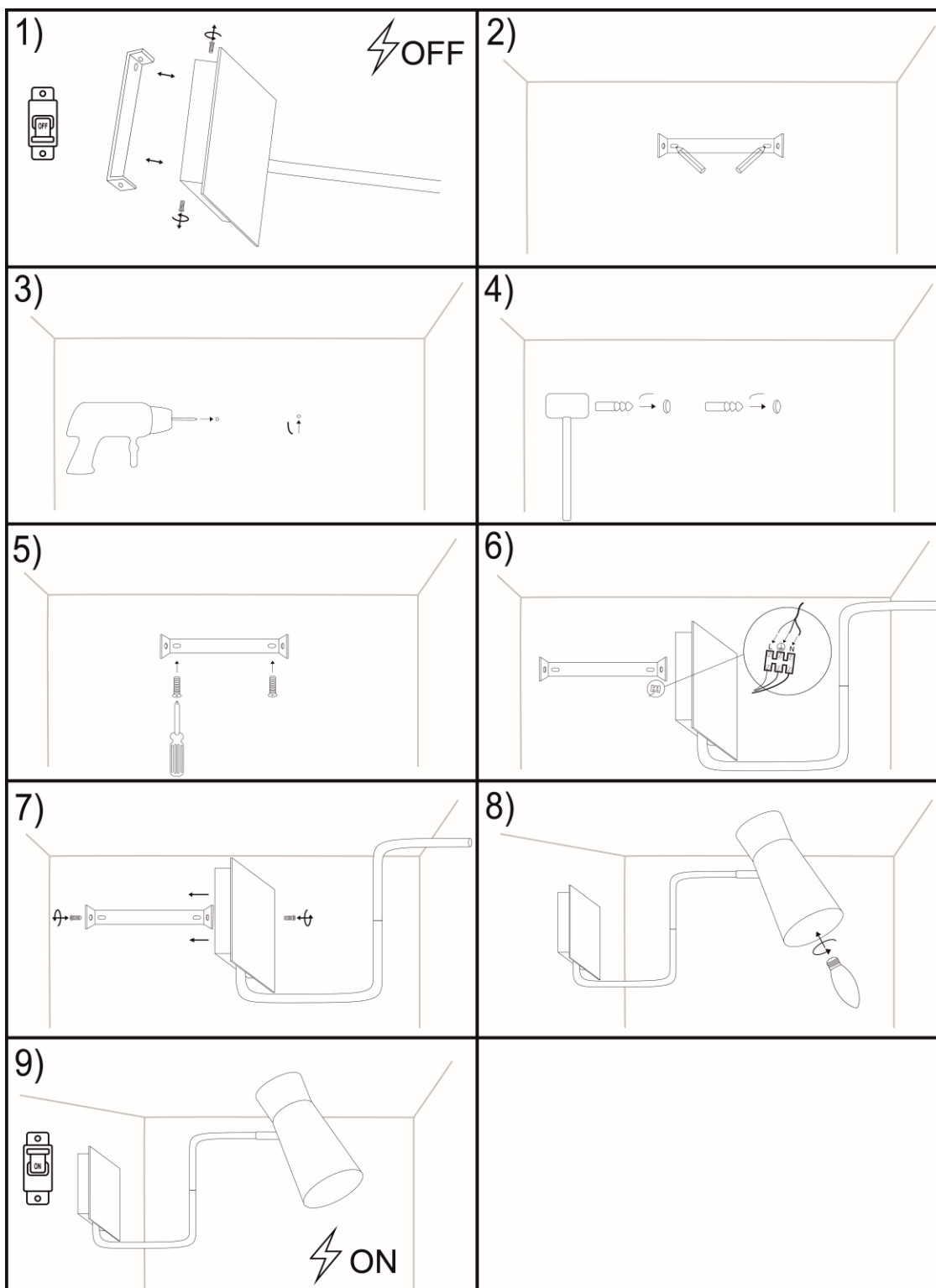
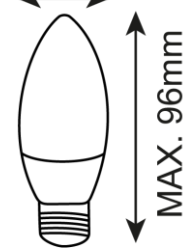

MAX. 35mm



E14 LED MAX 7W  LORD 8882



DE

L1

Stromleitung (Phase) braun

L

Stromleitung (Phase) schwarz

PE

Schutzleitung (gelb/grün)

N

Neutraler Leiter (null)



Schutzklasse II Lampe ohne Schutzleitung



Schutzklasse I Lampe mit Schutzleitung



Symbol für den Netzanschluss auf der Lampenseite



Symbol für den Netzanschluss auf der Hausseite

ENG

L1

Power wire (phase) brown

L

Power wire (phase) black

PE

Protective wire (yellow/green)

N

Neutral wire (blue)



Protection class II Lamp without protective conductor



Protection class I Lamp with protective conductor. Protective conductor - symbol.



Symbol for mains connection on the lamp side



Symbol for connection to the mains from the side of the house

PL

L1

Przewód prądowy (faza) brązowy

L

Przewód prądowy (faza) czarny

PE

Przewód ochronny (żółto/zielony)

N

Przewód zerowy (neutralny) niebieski



Klasa ochronna II Lampa bez przewodu ochronnego.



Klasa ochronna I Lampa z przewodem ochronnym. Przewód ochronny - symbol



Symbol Podłączenie do sieci od strony lampy



Symbol Podłączenie do sieci od strony domu