

# argon® LAMPY

TABOR 1865

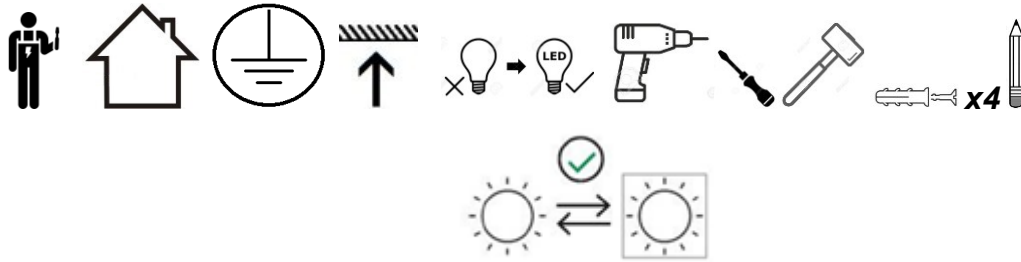

MAX. 50mm

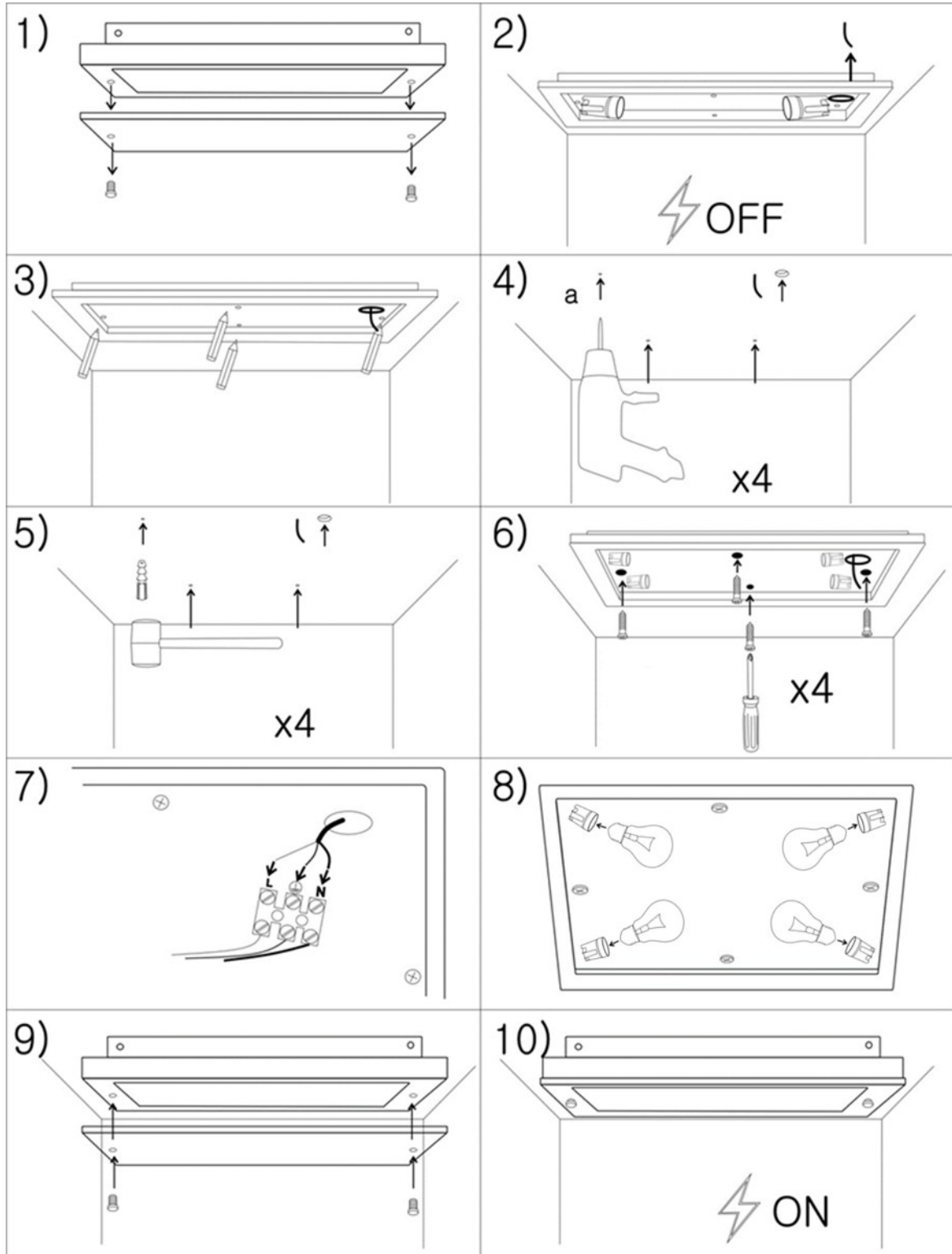
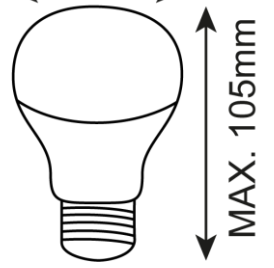

E27 LED MAX 15W  TABOR 1865

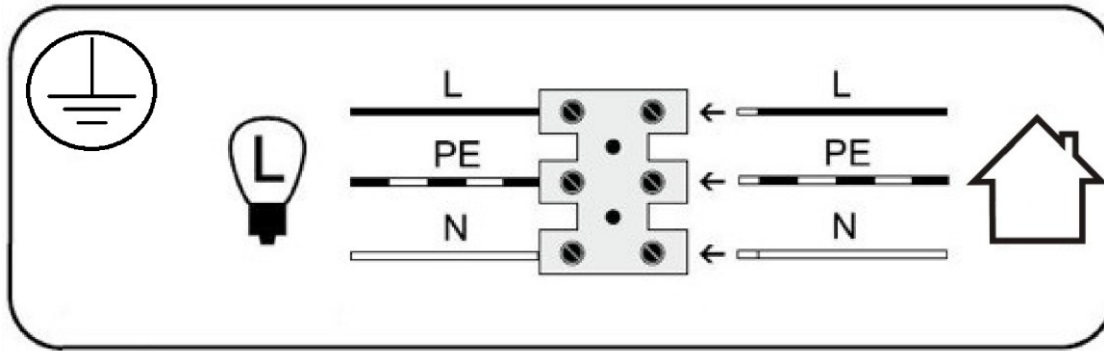

**DE**

**L1**

Stromleitung (Phase) braun

**L**

Stromleitung (Phase) schwarz

**PE**

Schutzleitung (gelb/grün)

**N**

Neutraler Leiter (null)



Schutzklasse II Lampe ohne Schutzleitung



Schutzklasse I Lampe mit Schutzleitung



Symbol für den Netzanschluss auf der Lampenseite



Symbol für den Netzanschluss auf der Hausseite

**ENG**

**L1**

Power wire (phase) brown

**L**

Power wire (phase) black

**PE**

Protective wire (yellow/green)

**N**

Neutral wire (blue)



Protection class II Lamp without protective conductor



Protection class I Lamp with protective conductor. Protective conductor - symbol.



Symbol for mains connection on the lamp side



Symbol for connection to the mains from the side of the house

**PL**

**L1**

Przewód prądowy (faza) brązowy

**L**

Przewód prądowy (faza) czarny

**PE**

Przewód ochronny (żółto/zielony)

**N**

Przewód zerowy (neutralny) niebieski



Klasa ochronna II Lampa bez przewodu ochronnego.



Klasa ochronna I Lampa z przewodem ochronnym. Przewód ochronny - symbol



Symbol Podłączenie do sieci od strony lampy



Symbol Podłączenie do sieci od strony domu