

### Connecting the Terminal Block

Connect main supply (brown - Live, blue - Neutral) into terminal block making sure all connections are tight.

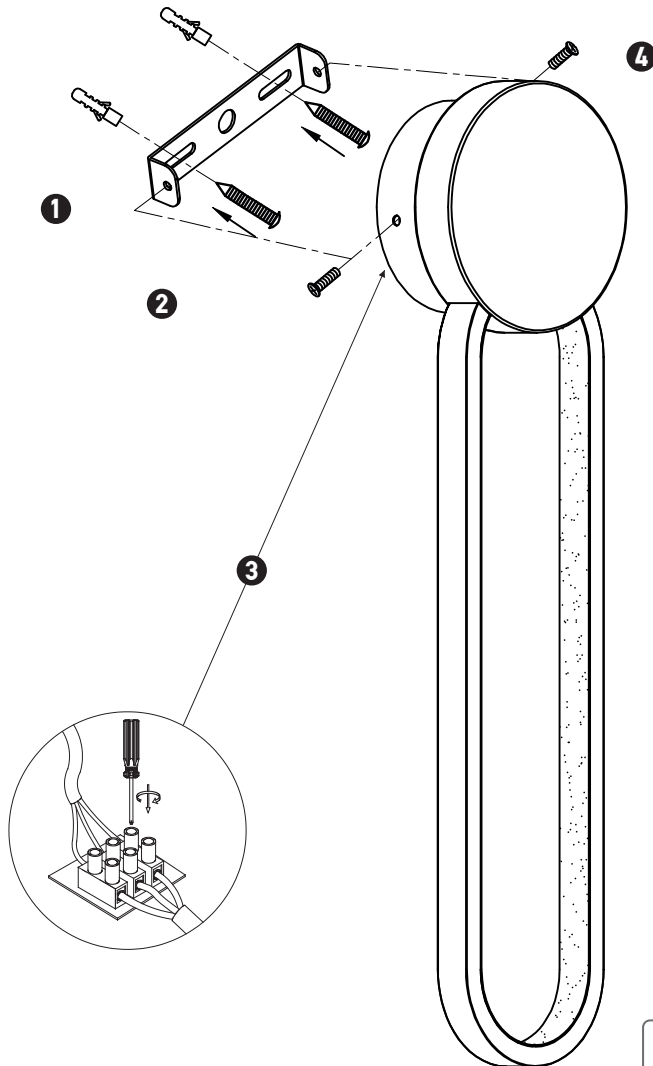
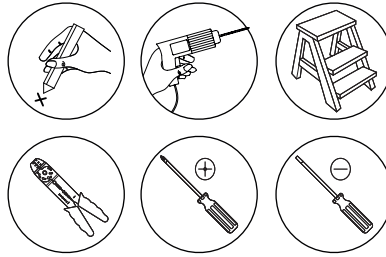

## INDOOR WALL LIGHT

23103

Please read instructions before commencing installation and retain for future reference.

### SPECIFICATIONS

- **Material:** Aluminum | Silicon
- **Lamp Type:** LED | 13W | 3000K | 765Lm | CRI 80
- **Ingress Protection:** IP20 Protection against entry of solid objects greater than 12mm in diameter.

### INSTALLATION INSTRUCTIONS

**⚠** Electrical products can cause death, injury, or property damage. Maintenance and installation should only be carried out by a professional electrician.

- Ensure the main supply is switched off.
- Insert the mounting anchors on the mounting surface (1).
- Fit mounting brackets onto mounting surface with the screws (2).
- Connect main supply wires to terminal block (3) making sure all connections are tight.
- Fit the light onto mounting brackets with the smallest screws (4).
- Reconnect power.

### WARNING

**⚠** Make sure that the products are installed properly before connecting to electricity. Do not cover the luminaire. Do not exceed the maximum wattage rating of the lamp. If the light source is contained in this luminaire (integrated LED), it shall only be replaced by the manufacturer, his service agent, or a similarly qualified person.

